

STANDARD TVS ARRAY

APPLICATIONS

- ✓ Computer Notebooks
- ✓ Communication Systems & Cellular Phones
- ✓ Printers
- ✓ Personal Digital Assistant (PDA)
- ✓ Video Equipment

IEC COMPATIBILITY (EN61000-4)

- ✓ 61000-4-2 (ESD): Air - 15kV, Contact - 8kV
- ✓ 61000-4-4 (EFT): 40A - 5/50ns

FEATURES

- ✓ 100 Watts Peak Pulse Power per Line ($t_p=8/20\mu s$)
- ✓ Monolithic Structure
- ✓ Available in 4 Voltage Types: 5V to 24V
- ✓ Low Clamping Voltage
- ✓ ESD Protection > 40 kilovolts
- ✓ Low Leakage Current
- ✓ Protects Three (3) Bidirectional Lines and Four (4) Unidirectional Lines

MECHANICAL CHARACTERISTICS

- ✓ Molded JEDEC SOT-553 Package
- ✓ Weight 4 milligrams (Approximate)
- ✓ Flammability rating UL 94V-0
- ✓ 12mm Tape and Reel Per EIA Standard 481
- ✓ Marking: Marking Code & Pin One Defined By Dot on Top of Package

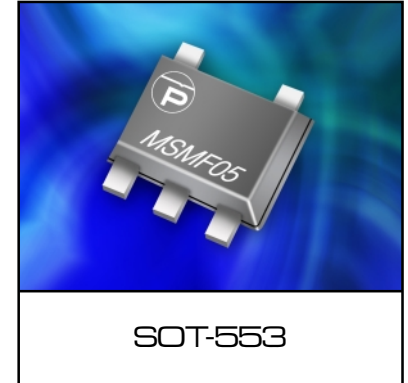

PIN CONFIGURATION

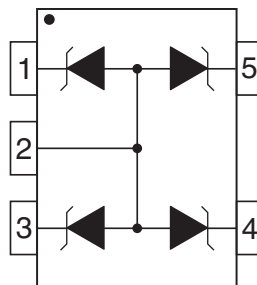

DEVICE CHARACTERISTICS

MAXIMUM RATINGS @ 25°C Unless Otherwise Specified			
PARAMETER	SYMBOL	VALUE	UNITS
Peak Pulse Power ($t_p = 8/20\mu s$) - See Figure 1	P_{PP}	100	Watts
Operating Temperature	T_J	-55°C to 150°C	°C
Storage Temperature	T_{STG}	-55°C to 150°C	°C
Maximum Forward Voltage @ 10mA	V_F	1.0	V

ELECTRICAL CHARACTERISTICS PER LINE @ 25°C Unless Otherwise Specified						
PART NUMBER	DEVICE MARKING	RATED STAND-OFF VOLTAGE	MINIMUM BREAKDOWN VOLTAGE	MAXIMUM CLAMPING VOLTAGE (See Fig. 2)	MAXIMUM LEAKAGE CURRENT	TYPICAL CAPACITANCE (See Note 1)
		V_{WM} VOLTS	@ 1mA $V_{(BR)}$ VOLTS	@8/20 μs $V_C @ I_{PP}$	@ V_{WM} I_D μA	0V @ 1 MHz C pF
MSMF05	A	5.0	6.0	12.0V @ 9.0A	1	40
MSMF12	C	12.0	13.3	23.8V @ 4.2A	1	20
MSMF15	E	15.0	16.7	33.3V @ 3.0A	1	15
MSMF24	G	24.0	26.7	55.5V @ 1.8A	1	10

Note 1: Pins 1, 3, 4, 5 or 6 to pin 2.

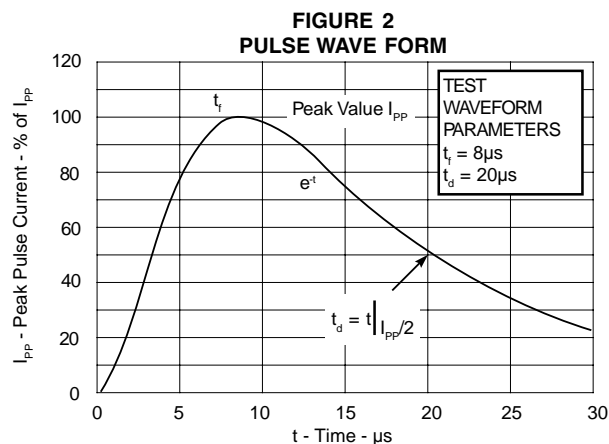
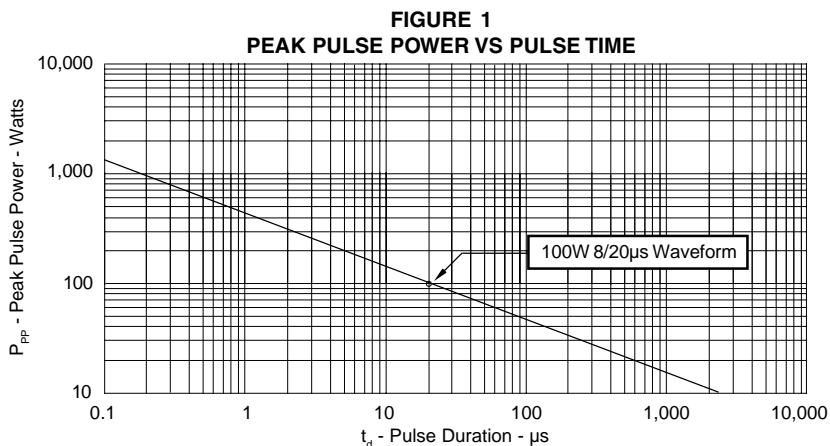

GRAPHS

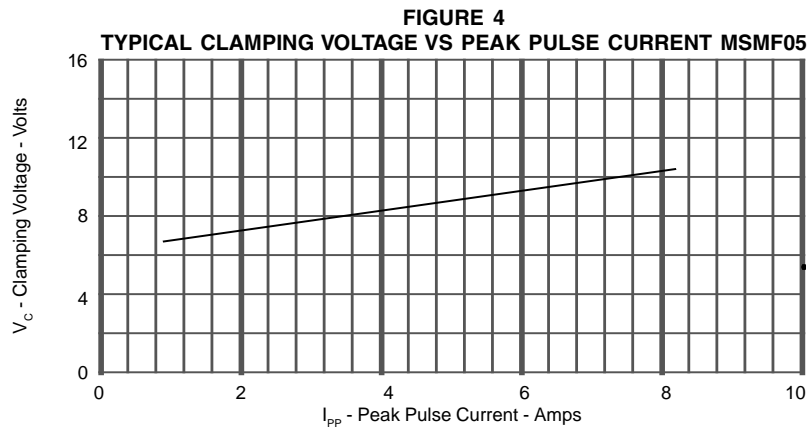
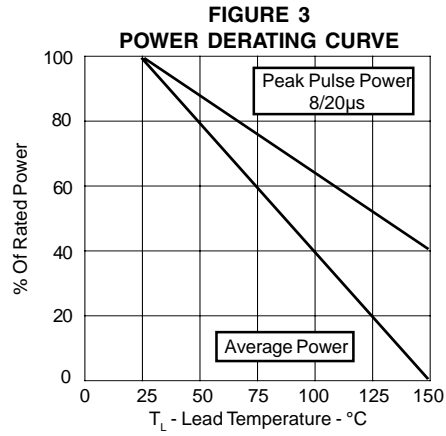

PACKAGE OUTLINE & DIMENSIONS

PACKAGE OUTLINE

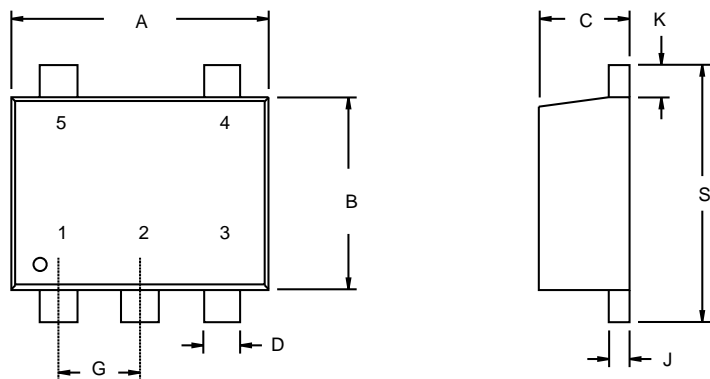

SOT-553

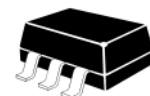

PACKAGE DIMENSIONS

DIM	MILLIMETERS		INCHES	
	MIN	MAX	MIN	MAX
A	1.50	1.70	0.059	0.067
B	1.10	1.30	0.043	0.051
C	0.50	0.60	0.020	0.024
D	0.17	0.27	0.007	0.011
G	0.50 BSC	-	0.020 BSC	-
J	0.08	0.16	0.003	0.007
K	0.10	0.30	0.004	0.012
S	1.50	1.70	0.059	0.067

MOUNTING PAD

TYPICAL		
DIM	Millimeters	Inches
1	0.30	0.012
2	1.02	0.040
3	0.51	0.020
4	1.40	0.055
5	0.51	0.020

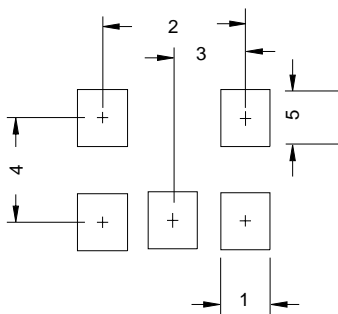

NOTES

1. Dimensioning and tolerances per ANSI Y14.5M, 1985.
2. Controlling Dimension: Inches
3. Pin 3 is the cathode (Unidirectional Only).
4. Dimensions are exclusive of mold flash and metal burrs.

TAPE & REEL/BULK ORDERING NOMENCLATURE

1. Surface mount product is taped and reeled in accordance with EIA-481.
2. Suffix -T7 = 7 Inch Reel - 3,000 pieces per 8mm tape, i.e., *MSMF05-T7*.
3. Suffix -T13 = 13 Inch Reel - 10,000 pieces per 8mm tape, i.e., *MSMF05-T13*.
4. Suffix-LF = Lead-Free, Pure Tin Plating, i.e., *MSMF05-LF-T7*.

Outline & Dimensions: Rev 0 - 12/03, 06050

COPYRIGHT © ProTek Devices 2004

SPECIFICATIONS: ProTek reserves the right to change the electrical and or mechanical characteristics described herein without notice (except JEDEC).

DESIGN CHANGES: ProTek reserves the right to discontinue product lines without notice, and that the final judgement concerning selection and specifications is the buyer's and that in furnishing engineering and technical assistance, ProTek assumes no responsibility with respect to the selection or specifications of such products.

ProTek Devices

2929 South Fair Lane, Tempe, AZ 85282

Tel: 602-431-8101 Fax: 602-431-2288

E-Mail: sales@protekdevices.com

Web Site: www.protekdevices.com